

# 5106 - VAULT

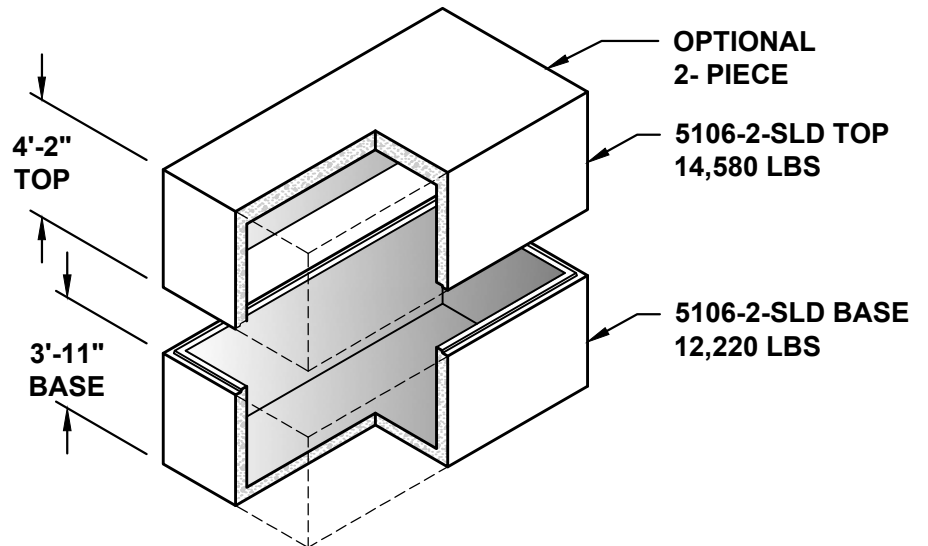
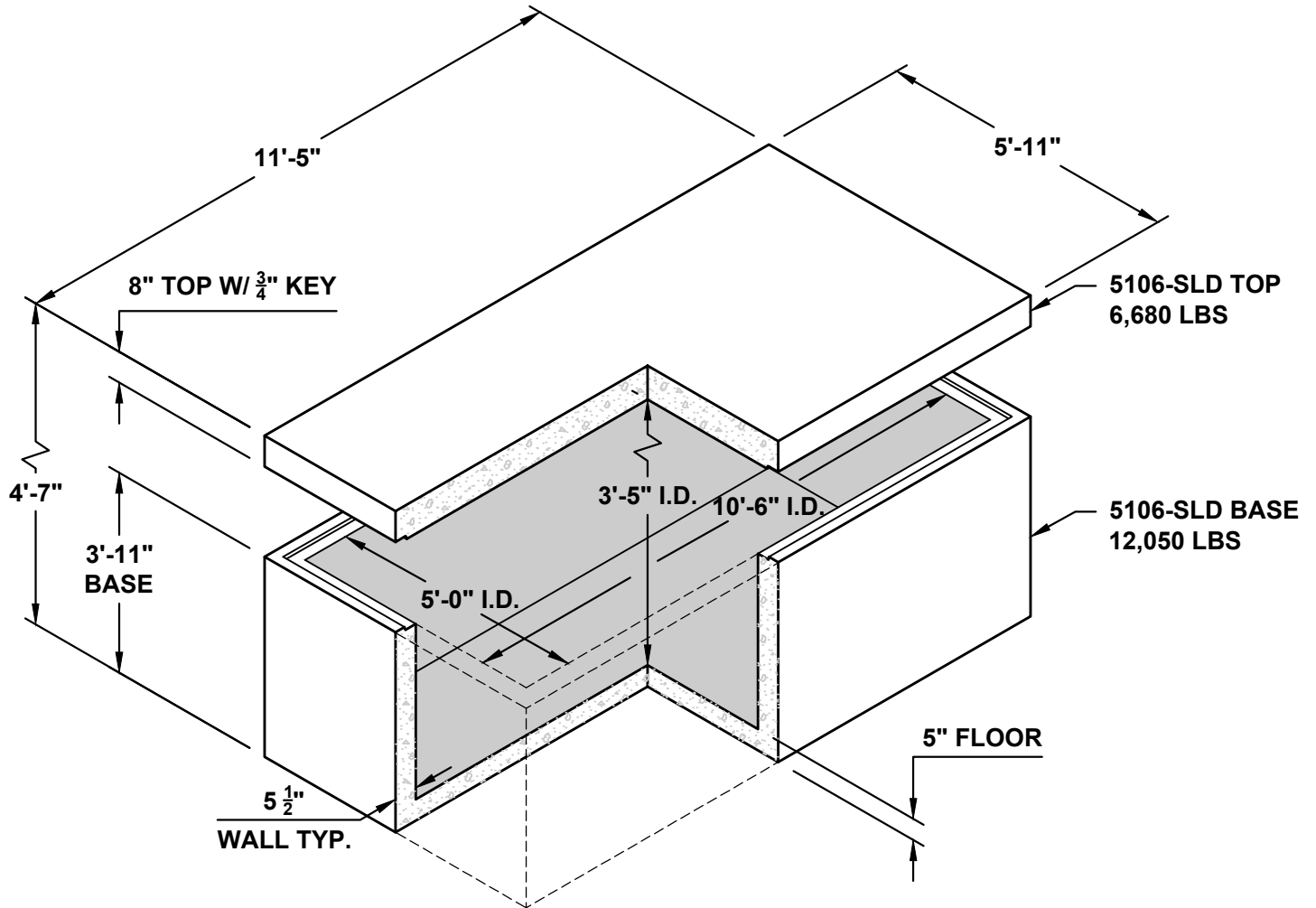

**NOTE:**  
 HEIGHT OF BASE & TOP ADJUSTABLE AS REQUIRED.  
 OPTIONAL TOP ACCESS, MANHOLE FRAME & COVERS, & HATCHES AS NEEDED. VARIES SIZES AVAILABLE.  
 OPTIONAL ACCESSORIES: STRUT CHANNEL, SUMPS, INSERTS, LADDERS, ETC.